

NOTES:

1. PART NUMBER CODE:

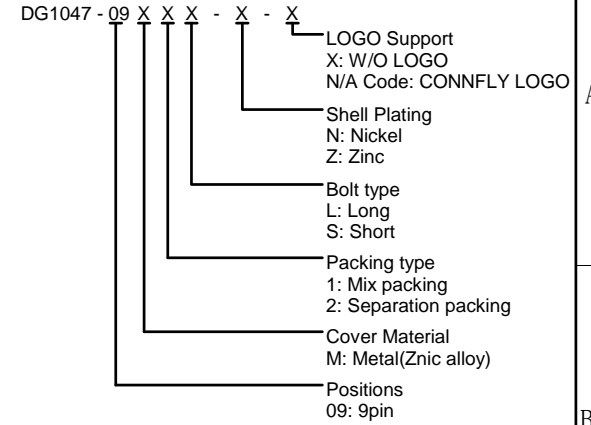

BOM LIST			
ITEM	PART NAME	Q'ty	NOTES
1	METAL HOOD	2	
2	LONG BOLT	2	
3	NUT	2	
4	SCREW-1	2	M3*12
5	WASHER	2	
6	SCREW-2	2	M3*6
7	SHORT BOLT	2	

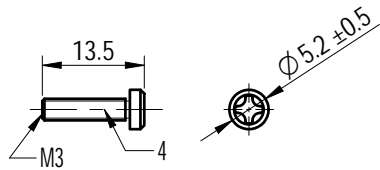
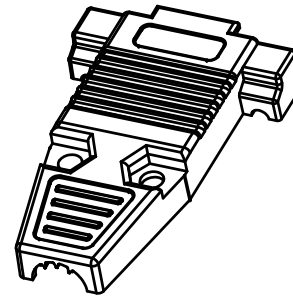

SCREW-1

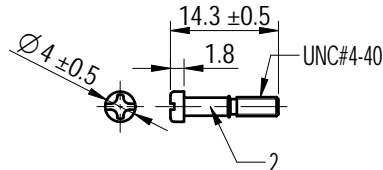

Short BOLT

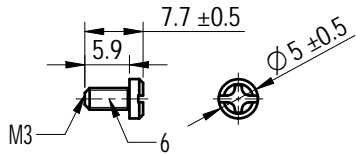

SCREW-2

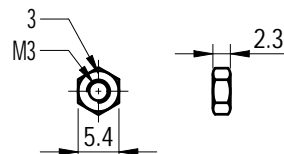

NUT

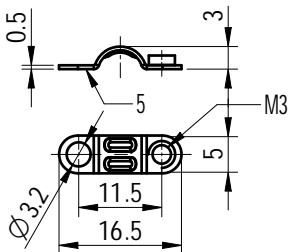

Metal

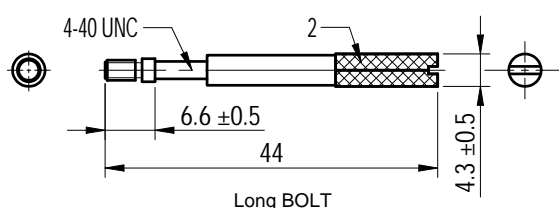

Long BOLT

GENERAL TOLERANCE

X.	±0.60
.X	±0.38
.XX	±0.25



MATERIAL:

SURFACE/COLOR:

MAT NO./REV: / 00

MAT STATUS: 批量

APPD: 兰春华 2023.07.31

NAME

CHKD: 陈招 2023.07.28

DG1047-09-XXXX-X-X

DRFT: 唐本恒 2023.07.27

DRAWING NO.	TYPE	DRAWING STATUS	SCALE	SHEET
200035065	CUSTOMER DRAWING	已发布	1:1	1/1

00	唐本恒	2023.07.27
REV	ECN	DESCRIPTION
DRFT	DATE	



Transfer or duplication of this document as well as the utilization or communication of its contents are prohibited unless explicit authorization is granted. Violations will be liable for compensation. All rights reserved for patent, utility model or design registrations. 未经授权复制或传播本文件内容，或在本文件内容基础上进行任何形式的使用，均属于侵权行为，公司将依法追究法律责任。本公司保留所有权利。