

2.1 ProfiNet fieldbus adapter (DF50-C-PN-RT)

- DF50-C-PN-RT The fieldbus adapter is connected to PROFINET IO as a slave station. PROFINET IO is an open Industrial Ethernet standard in the automation field. It can automatically configure and generate local process images that include analog, digital, and special functional modules. Analog modules and special function modules transmit data in the form of words or bytes, while digital modules transmit data in the form of bits.
- The fieldbus adapter can be integrated into applications as a PROFINET IO device.
- It is also equipped with a dual port switch, which can easily create a linear structure without the need for any other network components.
- Device names can be assigned through the DCP protocol.



2.1.1 Specification parameters

Technical Information

Specification parameters	PROFINET bus, 2 RJ45, expandable to 32 modules, 24VDC
Description	PROFINET
Connection method	2 * RJ45, integrated switch function
Transfer rate	10/100Mbps, full duplex
Transmission distance	100m
PDO data	1024 bytes
Number of expandable modules	32
Address mapping	Yes
Bus address settings	PROFINET specification
Transmission medium	Category 5 twisted pair
Method of electrical isolation	RT, compliant with Class C, MRP, automatic addressing/topology detection
Characteristic	Diagnostic alarm, process alarm; Connector alarm
Alarm	1ms
RT Bridge delay	<3usec
Internal system electrical terminal rated voltage input	24V DC (20.4V DC~ 28.8V DC)
Internal system electrical terminal rated current input	0.75A (Typical value at 24V)
Internal system electrical rated voltage output	5VDC
Internal system electrical rated current output	2A
Internal load electrical terminal rated voltage input	24V DC (20.4V DC~ 28.8V DC)

Internal load electrical terminal rated current input	0.75A (Typical value at 24V)
Internal load rated voltage output	24V DC (20.4V DC~ 28.8V DC)
Internal load rated current output	0.75A (Typical value at 24V)
DI parameters	
Signal (0) Input current of each channel (typical)	0.6mA
Signal (1) Input current of each channel (typical)	2.3mA
Signal (1) Minimum input current for each channel	2.1mA
Signal (1) Maximum input current of each channel	2.4mA
Filtering time	0.2-40ms configurable
Impedance	>7.5k Ω
Input action display	When the input is in the drive state, the input indicator light is on
IO mapping	Supports bitwise access, byte access, and two IO mapping methods
Wiring parameters	
communication/fieldbus	PROFINET IO: 2 * RJ-45
Connection technology	PUSH-IN type wiring port
line type	System/on-site power supply/input
Crimping area of wire	0.14~1.5mm ² /26~16AWG
Strip length	8~10mm
Installation method	DIN-35 type guide rail
Material parameters	
Colour	Black
Housing material	PC plastic, PA66
Consistency flag	CE

Environmental requirements	
Permissible ambient temperature (during operation)	-25~60°C
Permissible ambient temperature(storage)	-40~85°C
Protection type	IP20
Pollution leve	2. Comply with IEC 61131-2 standard
Working altitude	Without temperature influence:0~2000m
Relative humidity (non condensing)	5~95%RH
Anti vibration	4g, Complies with IEC 60068-2-6 standard
Impact resistance	15g, Complies with IEC 60068-2-27 standard
EMC - Immunity	Complies with EN 61000-6-2 standard
EMC-Radiated Interference	Complies with EN 61000-6-3 standard
Corrosion resistance	Complies with IEC 60068-2-42 and IEC 60068-2-43 standards
Permissible H2S pollutant concentration at 75% relative humidity	10ppm
Permissible SO2 pollutant concentration at 75% relative humidity	25ppm

2.2 Hardware interface

2.2.1 Terminal Definition

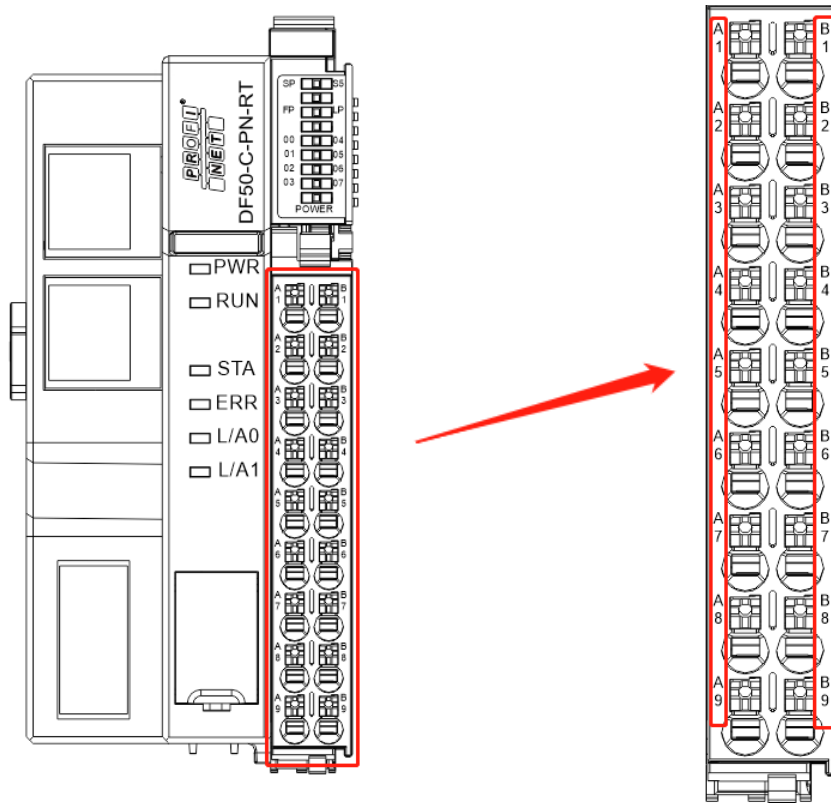

Serial Number	Signal	Serial Number	Signal	explanatory note
A1	Sys-24V	B1	Sys-0V	System power supply
A2	Field-24V	B2	Field-0V	Load power supply Internal connection, only 1 set of power supply is connected
A3	Field-24V	B3	Field-0V	
A4	PE	B4	PE	Grounding terminal
A5	DI0	B5	DI4	Signal input
A6	DI1	B6	DI5	
A7	DI2	B7	DI6	
A8	DI3	B8	DI7	
A9	COM	B9	COM	Common terminal

Note: It is recommended to use two 24V power sources that are isolated from each other to provide

two separate power sources for the coupler to achieve optimal anti-interference performance.

2.2.2 Definition of LED indicator lights

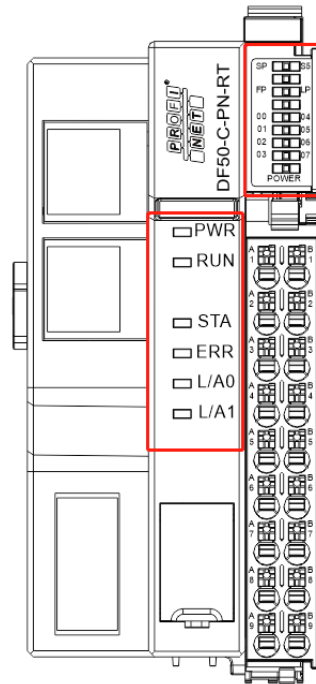

Pilot lamp	Status	explanatory note
PWR	Green light on	The power supply is running normally
	Green light off	Abnormal power operation
RUN	Green light on	The bus adapter is working properly
	Green light off	Abnormal operation of bus adapter
STA	Green light flashing	The IO module is operating normally
	Green light off	Abnormal operation of IO module
ERR	Red light on	Abnormal communication between bus adapter and IO module
	Red light off	Communication between bus adapter and IO module is normal
L/A0	Green light on	Successfully connected to network port 1
	Green light flashing	Network port 1 has data communication
L/A1	Green light on	Successfully connected to network port 2
	Green light flashing	Network port 2 has data communication
FP	Green light on	Load power input is normal
	Green light off	Abnormal load power input
LP	Green light on	The load power output is normal
	Green light off	Abnormal output of load power supply
SP	Green light on	The system power input is normal
	Green light off	Abnormal system power input
S5	Green light on	The system power output is normal
	Green light off	Abnormal system power output

2.2.3 RJ45 interface

Used to establish communication with the upper computer/PLC, dual RJ45 ports can easily create a linear structure without the need for any other network components.

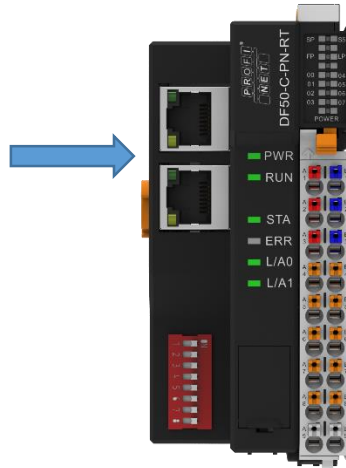

2.2.4 Dial switch

There is a function definition, 0: the device name is set on the upper computer/PLC, 1-255: the device name is PN-1~PN-255

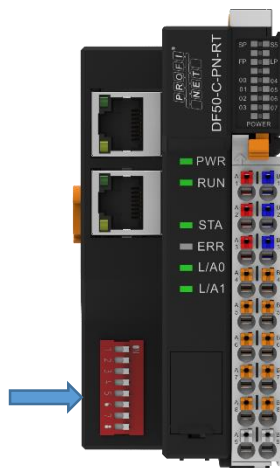

2.2.5 Wiring diagram

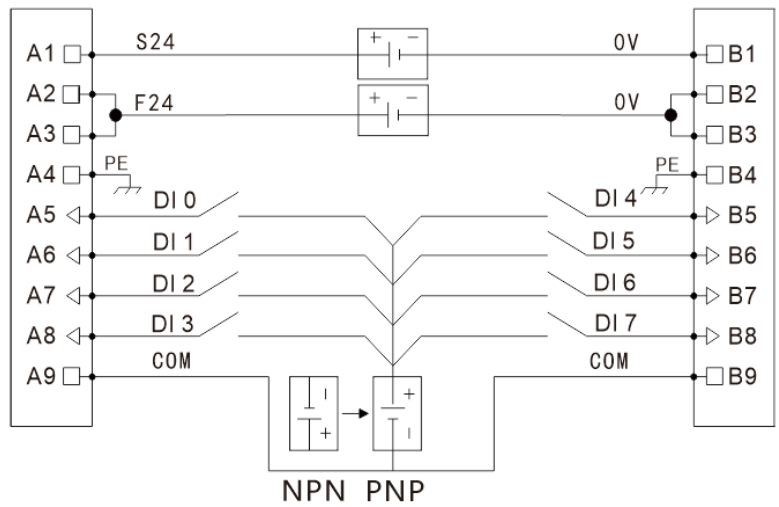
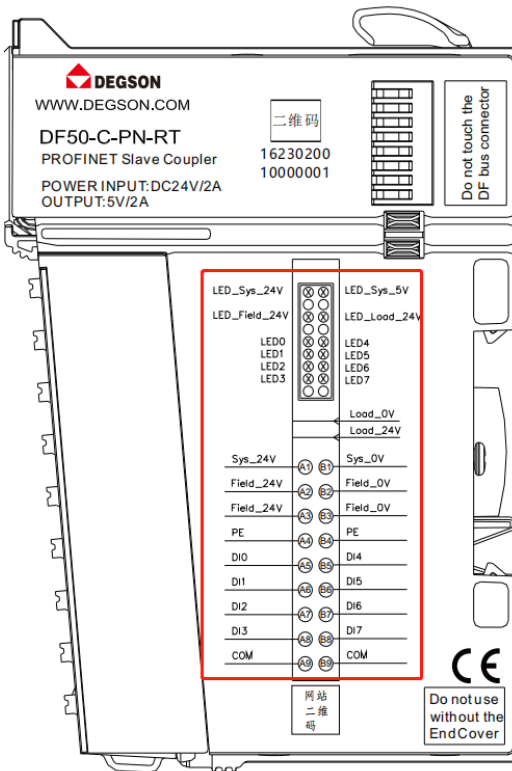

Note: COM is a public terminal that is externally connected to 24V for NPN implementation. External access to 0V to achieve PNP.

2.2.6 Configuration interface

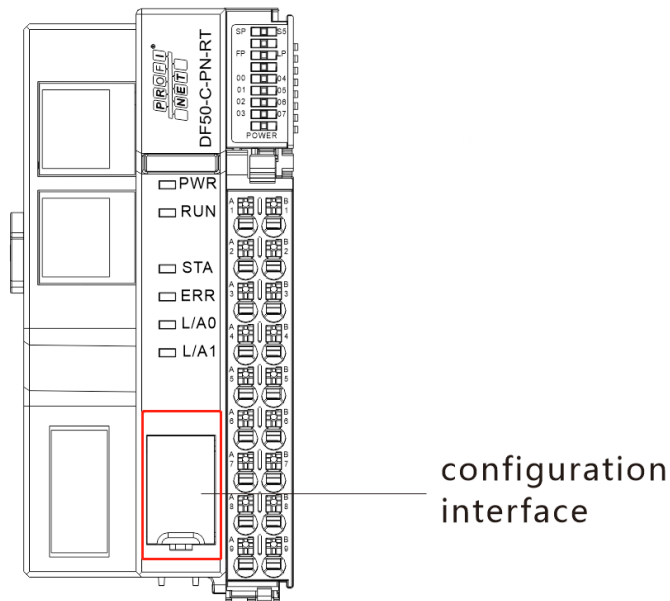

Equipped with a download interface, the flip can be opened for easy firmware upgrade of the adapter.

Note: Non professional and unauthorized personnel are prohibited from using this interface to avoid firmware issues.

2.3 Mechanical Installation

2.3.1 Installation dimensions

The installation size information is shown in the following figure:

DF50-C-PN-RT Fieldbus adapter
(DF50-C-PN-RT)

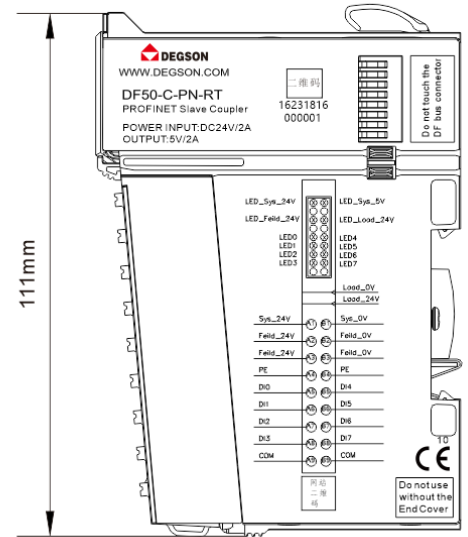
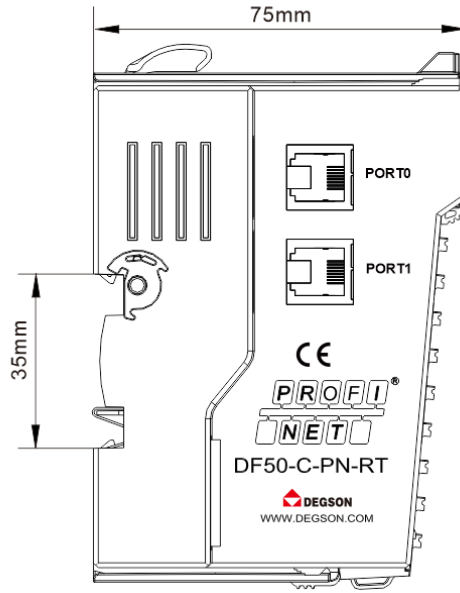
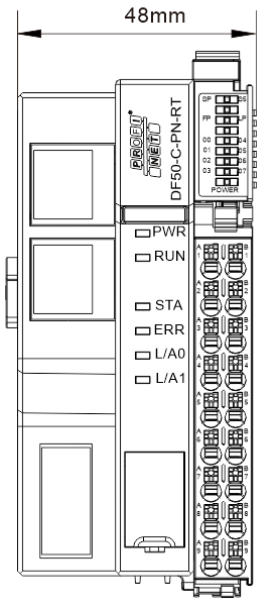

DF50-C-PN-RT Fieldbus adapter
(DF50-C-PN-RT)